

## 20 WATT REGULATED DC/DC CONVERTER

### WPN20R



#### APPLICATIONS

- Telecommunication Applications
- Battery Powered Systems
- Process Control Equipment
- Transportation Equipment
- Distributed Power Systems

#### SIMPLIFIED CIRCUIT DIAGRAM

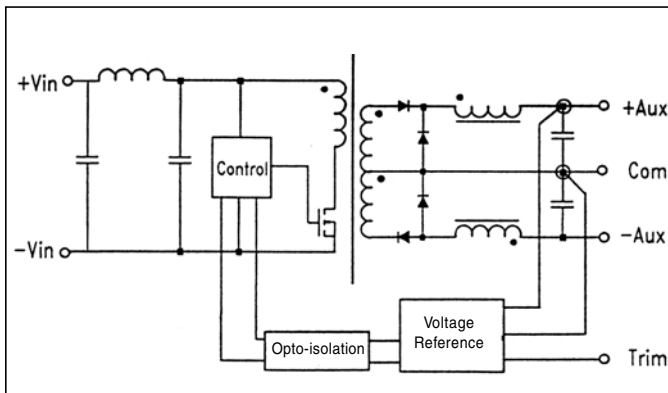

#### FEATURES

- INPUT AND OUTPUT FILTERING
- SINGLE AND DUAL OUTPUTS
- OPERATING CASE TEMPERATURE RANGE: -40°C TO 100°C
- INDUSTRY STANDARD PINOUT
- REMOTE ON/OFF FUNCTION
- HIGH EFFICIENCY
- OUTPUT TRIM FUNCTION
- SHORT CIRCUIT PROTECTION
- ZERO LOAD OPERATION
- EN 60950, UL1950, C-UL, VDE AGENCY APPROVALS
- LOW PROFILE SHELL

#### DESCRIPTION

The WPN20R series is a family of high performance DC/DC converters available in three input voltage ranges of 9-18V, 18-36V and 33-75V. The unit is housed in a space saving aluminum shell and combines low cost with high performance across all line and load conditions. The 300KHz switching frequency and forward converter topology provide excellent performance across all line and load conditions in a space saving package. Other features include: full regulation down to zero load, under voltage lock-out, internal temperature shutdown, soft start, remote on/off and over current protection.

An output trim feature is provided, allowing the user to compensate for long line lengths. The WPN20R Series is assembled using a fully automated process incorporating 100% surface mounted components for increased reliability.

#### AGENCY APPROVALS



Internet: <http://www.cdpowerelectronics.com>

Power Electronics Division, United States  
3400 E Britannia Drive, Tucson, Arizona 85706  
Phone: 800.547.2537 Fax: 520.770.9369

Power Electronics Division, Europe  
C&D Technologies (Power Electronics) Ltd.  
132 Shannon Industrial Estate, Shannon, Co. Clare, Ireland  
Tel: +353.61.474.133 Fax: +353.61.474.141

# ELECTRICAL SPECIFICATIONS

Specifications typical at  $T_A=25^{\circ}\text{C}$ , nominal input voltage, rated output current unless otherwise stated.

MODEL	NOMINAL INPUT VOLTAGE (V <sub>DC</sub> )	RATED OUTPUT VOLTAGE (V <sub>DC</sub> )	OUTPUT CURRENT		INPUT CURRENT NOM LOAD (A)	EFFICIENCY (%)
			MIN LOAD (A)	NOM LOAD (A)		
WPN20R12S03	12	3.3	0.0	6.00	2.00	82
WPN20R12S05	12	5.0	0.0	4.00	2.00	84
WPN20R12S12	12	12.0	0.0	1.66	2.00	86
WPN20R12S15	12	15.0	0.0	1.33	2.00	86
WPN20R12D05	12	±5.0	0.0	±2.00	2.00	84
WPN20R12D12	12	±12.0	0.0	±0.83	2.00	86
WPN20R12D15	12	±15.0	0.0	±0.67	2.00	86
WPN20R24S03	24	3.3	0.0	6.00	1.00	83
WPN20R24S05	24	5.0	0.0	4.00	1.00	84
WPN20R24S12	24	12.0	0.0	1.66	1.00	87
WPN20R24S15	24	15.0	0.0	1.33	1.00	87
WPN20R24D05	24	±5.0	0.0	±2.00	1.00	85
WPN20R24D12	24	±12.0	0.0	±0.83	1.00	87
WPN20R24D15	24	±15.0	0.0	±0.67	1.00	87
WPN20R48S03	48	3.3	0.0	6.00	0.50	83
WPN20R48S05	48	5.0	0.0	4.00	0.50	85
WPN20R48S12	48	12.0	0.0	1.66	0.50	88
WPN20R48S15	48	15.0	0.0	1.33	0.50	86
WPN20R48D05	48	±5.0	0.0	±2.00	0.50	85
WPN20R48D12	48	±12.0	0.0	±0.83	0.50	87
WPN20R48D15	48	±15.0	0.0	±0.67	0.50	87

# COMMON SPECIFICATIONS

Specifications typical at  $T_A=25^{\circ}\text{C}$ , nominal input voltage, rated output current unless otherwise stated.

PARAMETER	CONDITIONS	MIN	TYP	MAX	UNITS
<b>INPUT</b>					
Voltage Range		9	12	18	V <sub>DC</sub>
		18	24	36	V <sub>DC</sub>
		33	48	75	V <sub>DC</sub>
Reflected Ripple Current	All Input Ranges			50	mApk-pk
<b>INPUT CONTROL</b>					
Temperature Shutdown	Case	105		115	°C
Temperature Hysteresis			10		°C
Quiescent Standby Current	Current Into + V <sub>IN</sub>		8	10	mA
Undervoltage Control	See Attached Plots				
<b>ISOLATION</b>					
Rated Voltage		1500			V <sub>DC</sub>
Test Voltage	60Hz, 10 Seconds	1500			V <sub>DC</sub>
Resistance			10		GΩ
Capacitance			400		pF
Leakage Current			30		μArms
<b>OUTPUT</b>					
Rated Power				20	W
Voltage Setpoint Accuracy				±1.5	%
Temperature Coefficient				±0.005	%/°C
Line Regulation					
Singles	High Line to Low Line			±0.1	%
DUALS	High Line to Low Line			±0.5	%
Load Regulation					
Singles	Mn Load to Nom. Load			±0.5	%
DUALS	Mn Load to Nom. Load			±2.0	%
Ripple & Noise					
Single Outputs	BW = 5Hz to 20MHz		60	100	mVp-p
Dual Outputs	BW = 5Hz to 20MHz		50	100	mVp-p
Output Adjust Range	See Attached Plots				
Short Circuit and Overcurrent Protection	Continuous				
Max Capacitive Load			550		μF/A
<b>GENERAL</b>					
Switching Frequency			300		KHz
MTTF per ML-HDBK-217	Circuit Stress Method				
Ground Benign	TA = +25° Unmodified Database		1,400,000		Hr
Package Weight			32		g
<b>TEMPERATURE</b>					
Specification	Case	-40		+ 85	°C
Operation	Case	-40		+ 85	°C
Storage		-55		+125	°C

# ORDERING INFORMATION

**WPN20R** **xyzz**

Device family \_\_\_\_\_

Model No. \_\_\_\_\_

xx = input range, e.g.48V  
 y = no. of outputs e.g. 'S' for single, 'D' for dual  
 zz = output voltage, e.g. '05' for 5V

# REMOTE ON/OFF CONTROL

Logic Compatibility .....Open Collector TTL  
 EC ON.....Open circuit  
 EC OFF .....< 0.7V  
 Shutdown Idle current.....8mA

## MECHANICAL

**TOP VIEW**

**WPN20Rxyzz**

PIN CONNECTIONS		
PIN#	SINGLES	DUALS
1	+VIN	+VIN
2	-VIN	-VIN
3	NO PIN	NO PIN
4	Remote On/Off	Remote On/Off
5	NO PIN	+VOUT
6	+VOUT	COMMON
7	-VOUT	-VOUT
8	TRIM	TRIM

**SIDE VIEW**

**BOTTOM VIEW**

**NOTES:**  
 All dimensions are in inches (millimeters).  
 GRID: 0.100 inches (2.54 millimeters)  
 Pin Placement: Tolerance: ±0.015  
 Marked with: specific model ordered, date code, job code.  
 MATERIAL: Units are encapsulated in a low thermal resistance molding compound which has excellent chemical resistance, wide operating temperature range, and good electrical properties under high humidity environments. The encapsulant and outer shell of the unit have UL94V-0 ratings. Lead material is brass with a solder plated surface to allow ease of solderability.

Standard Options are shown, consult factory for other available options.

The information provided herein is believed to be reliable; however, C&D TECHNOLOGIES assumes no responsibility for inaccuracies or omissions. C&D TECHNOLOGIES assumes no responsibility for the use of this information, and all use of such information shall be entirely at the user's own risk. Prices and specifications are subject to change without notice. No patent rights or licenses to any of the circuits described herein are implied or granted to any third party. C&D TECHNOLOGIES does not authorize or warrant any C&D TECHNOLOGIES product for use in life support devices/systems or in aircraft control applications.

# PERFORMANCE GRAPHS

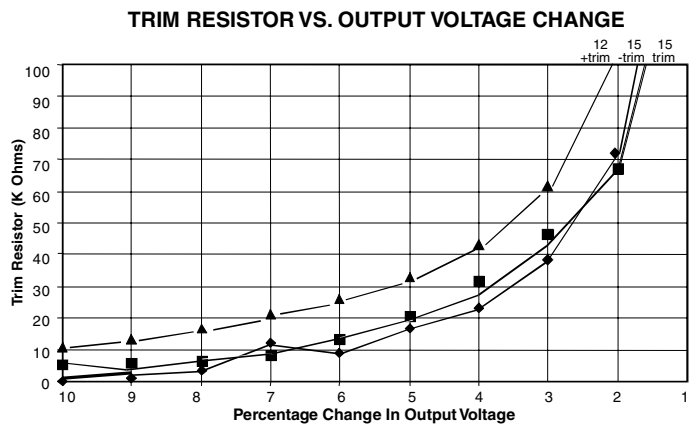
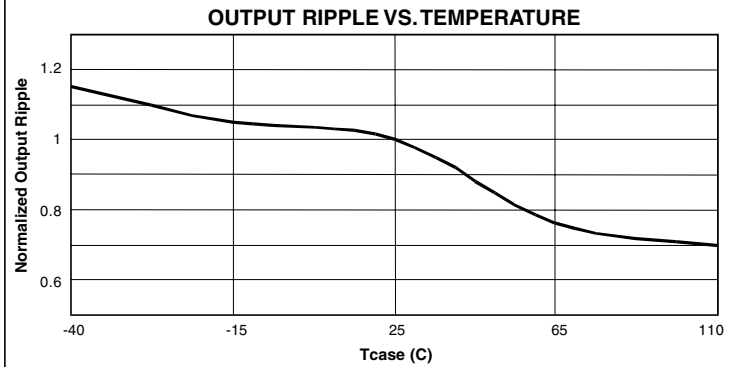
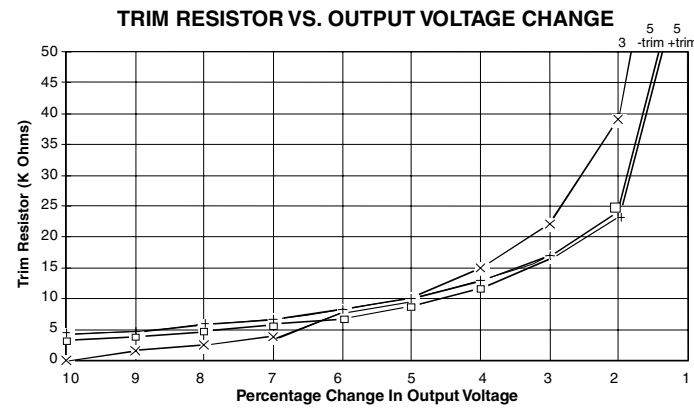
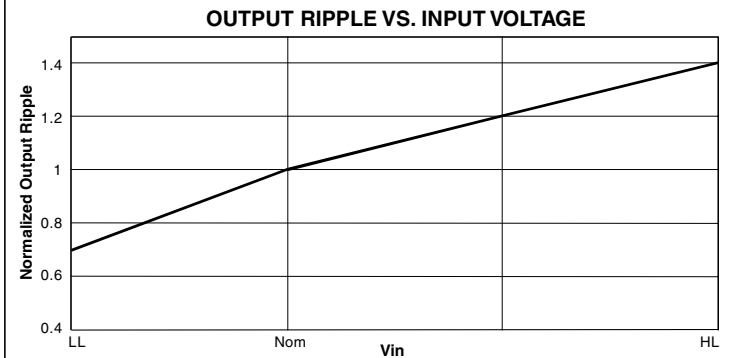
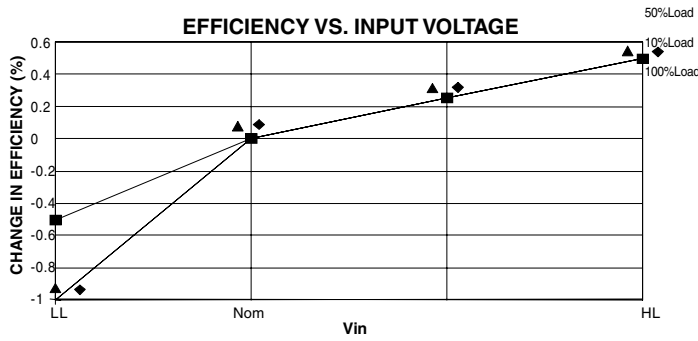
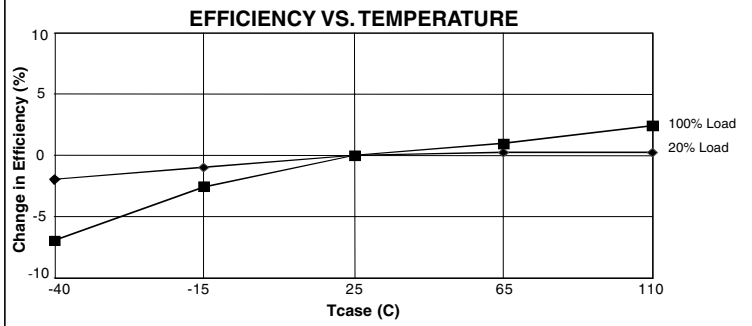
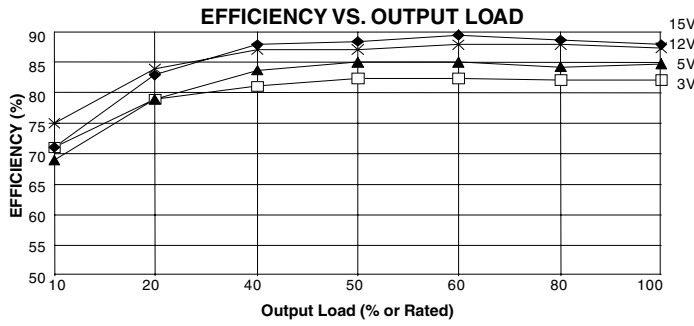

## THERMAL DERATING CURVE

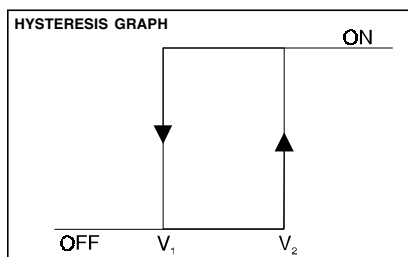
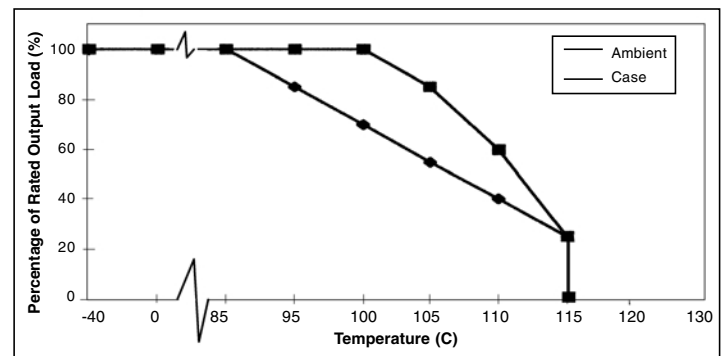

## Undervoltage Lockout Threshold Voltages

Nominal Input Voltage Range	Shutdown Low Voltage (V1) OFF	Shutdown High Voltage (V2) ON
12	7	8.8
24	15.5	17
48	30	33

Specifications typical at TA=25°C, rated output current.